



ELECTRICAL CATALOGUE

Electrical Connectors & Cables

Terminal Mounting Boxes

Hot Runner Controllers

Heaters & Thermocouple

Contents	pg
Mould Side Connectors (By Zones)	3
Connector Hoods	14
Terminal Mounting Boxes	21
Temperature Controller Cables	24
Temperature Controllers	26
Sequential Controllers	40
Spare Parts	42
Nozzle Heaters	44
Sprue Bush Heaters	56
VeriShot™ Heater	56
Manifold Heaters	57
Heater Spare Parts	58
Nozzle Thermocouple	59
Manifold Thermocouple	60

Mould Side Connectors

1 Zone , 5 Pin - Single Latch			
Male Type			
Connector Base Dimensions	Connector Assembly	Components	
Item Description	Mould Side Connector	Connector Base	Insert - 5 Pin 10A
Mastip Product Code	79-000-006	29-100-002	29-100-003
Industry Reference Code			
International	CKPTIC-1		
Harting		Han 3A-HBM-SL 09 20 003 0301	Han 4A-STI-S 09 20 004 2611
ILME		CKA 03 I	CKM 04
Weiland			73.310.0453.0
Weidmuller		HDC 07A ALU 1652410000	HDC HA 4 MS1498300000
Female Type			
Connector Base Dimensions	Connector Assembly	Components	
Item Description	Mould Side Connector	Connector Base	Insert - 5 Pin 10A
Mastip Product Code	79-000-040	29-100-002	29-100-004
Industry Reference Code			
International	CKPTOC-1		
Harting		Han 3A-HBM-SL 09 20 003 0301	Han 4A-BU-S 09 20 004 2711
ILME		CKA 03 I	CKF 04
Weiland			73.300.0453.0
Weidmuller		HDC 07A ALU 1652410000	HDC HA 4 FS 1498400000





Mould Side Connectors

5 Zone , 10 Pin - Single Latch			
Male Type			
Connector Base Dimensions	Connector Assembly	Components	
			
Item Description	Mould Side Connector	Connector Base	Insert - 10 Pin 16A
Mastip Product Code	79-000-031	29-100-016	29-100-010
Industry Reference Code			
International	MTC-5-G		
Harting		Han B Base Panel 1 Lever 09 30 010 0305	Han E 10 Pos. M 09 33 010 2601
ILME		CHI 10L	CNEM 10T
Weiland			
Weidmuller		HDC 10B ALU 1206100000	HDC HE 10 MS 1203900000
Female Type			
Connector Base Dimensions	Connector Assembly	Components	
			
Item Description	Mould Side Connector	Connector Base	Insert - 10 Pin 16A
Mastip Product Code	79-000-041	29-100-016	29-100-013
Industry Reference Code			
International			
Harting		Han B Base Panel 1 Lever 09 30 010 0305	Han E 10 Pos. F 09 33 010 2701
ILME		CHI 10L	CNEF 10T
Weiland			
Weidmuller		HDC 10B ALU 1206100000	HDC HE 10 FS 1204100000

Mould Side Connectors

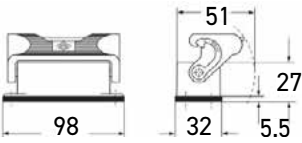
5 Zone , 10 Pin - Double Latch			
Male Type			
Connector Base Dimensions	Connector Assembly	Components	
Item Description	Mould Side Connector	Connector Base	Insert - 10 Pin 16A
Mastip Product Code	79-000-042	29-100-395	29-100-010
Industry Reference Code			
International			
Harting		Han B Base Panel 2 levers 09 30 010 0301	Han E 10 Pos. M 09 33 010 2601
ILME		CHI 10	CNEM 10T
Weiland			
Weidmuller		HDC 10B ABU N 2488580000	HDC HE 10 MS 1203900000
Female Type			
Connector Base Dimensions	Connector Assembly	Components	
Item Description	Mould Side Connector	Connector Base	Insert - 10 Pin 16A
Mastip Product Code	79-000-043	29-100-395	29-100-013
Industry Reference Code			
International			
Harting		Han B Base Panel 2 levers 09 30 010 0301	Han E 10 Pos. F 09 33 010 2701
ILME		CHI 10	CNEF 10T
Weiland			
Weidmuller		HDC 10B ABU N 2488580000	HDC HE 10 FS 1204100000

Mould Side Connectors

5 or 6 Zone , 25 Pin - Single Latch				
Male Type				
Connector Base Dimensions	Connector Assembly	Components		
				
Item Description	Mould Side Connector	Connector Base	Insert - 25 Pin 10A	Pin 1.5mm
Mastip Product Code	79-000-012	29-100-025	29-100-028	29-100-349
Industry Reference Code				
International	PIC-5-G			
Harting		Han 16A-HBM-SL 09 20 016 0301	Han D 25 Pos. M 09 21 025 3001	R 15-STI-C-1,5 09 15 000 6101
ILME		CZI 25L	CDM 25	CDMA1.5
Weiland				
Weidmuller		HDC 16A ALU 1664920000	HDC HD 25 MC 1650810000	HDC-C-HD-SM1.5AG 1651550000

Mould Side Connectors

8 Zone , 16 Pin - Single Latch			
Male Type			
Connector Base Dimensions	Connector Assembly	Components	
			
Item Description	Mould Side Connector	Connector Base	Insert - 16 Pin 16A
Mastip Product Code	79-000-032	29-100-017	29-100-011
Industry Reference Code			
International	MTC-8-G		
Harting		Han 16B-HBM single lever 09 30 016 0307	Han E 16 Pos. M 09 33 016 2601
ILME		CHI 16L	CNEM 16T
Weiland			
Weidmuller		HDC 16B ALU 1209700000	HDC HE 16 MS 1207500000
Female Type			
Connector Base Dimensions	Connector Assembly	Components	
			
Item Description	Mould Side Connector	Connector Base	Insert - 16 Pin 16A
Mastip Product Code	79-000-033	29-100-017	29-100-014
Industry Reference Code			
International			
Harting		Han 16B-HBM single lever 09 30 016 0307	Han 16E-bu-s 09 33 016 2701
ILME		CHI 16L	CNEF 16T
Weiland			
Weidmuller		HDC 16B ALU 1209700000	HDC HE 16 FS 1207700000

Mould Side Connectors

8 Zone , 16 Pin - Double Latch			
Male Type			
Connector Base Dimensions	Connector Assembly	Components	
Item Description	Mould Side Connector	Connector Base	Insert - 16 Pin 16A
Mastip Product Code	79-000-034	29-100-328	29-100-011
Industry Reference Code			
International			
Harting		Han 16B-HBM-double lever 09 30 016 0301	Han E 16 Pos. M 09 33 016 2601
ILME		CHI 16	CNEM 16T
Weiland			
Weidmuller		HDC 16B ABU N 2488590000	HDC HE 16 MS 1207500000
Female Type			
	Connector Assembly	Components	
Item Description	Mould Side Connector	Connector Base	Insert - 16 Pin 16A
Mastip Product Code	79-000-035	29-100-328	29-100-014
Industry Reference Code			
International			
Harting		Han 16B-HBM-double lever 09 30 016 0301	Han 16E-bu-s 09 33 016 2701
ILME		CHI 16	CNEF 16T
Weiland			
Weidmuller		HDC 16B ABU N 2488590000	HDC HE 16 FS 1207700000

Mould Side Connectors

8 Zone , 25 Pin - Single Latch				
Male Type				
	Connector Assembly	Components		
Item Description	Mould Side Connector	Connector Base	Insert - 25 Pin 10A	Pin 1.5mm
Mastip Product Code	79-000-013	29-100-025	29-100-028	29-100-349
Industry Reference Code				
International	PIC-8-G			
Harting		Han 16A-HBM-SL 09 20 016 0301	Han D 25 Pos. M 09 21 025 3001	R 15-STI-C-1,5 09 15 000 6101
ILME		CZI 25L	CDM 25	CDMA1.5
Weiland				
Weidmuller		HDC 16A ALU 1664920000	HDC HD 25 MC 1650810000	HDC-C-HD-SM1.5AG 1651550000

Mould Side Connectors

12 Zone , 24 Pin - Single Latch			
Male Type			
Connector Base Dimensions	Connector Assembly	Components	
			
Item Description	Mould Side Connector	Connector Base	Insert - 24 Pin 16A
Mastip Product Code	79-000-036	29-100-018	29-100-012
Industry Reference Code			
International	MTC-12-G		
Harting		Han 24B-Base Panel 1 Lever 09 30 024 0307	Han E 24 Pos. M 09 33 024 2601
ILME		CHI 24L	CNEM 24T
Weiland			
Weidmuller		HDC 24B ALU 1213900000	HDC HE 24 MS 1211100000
Female Type			
Connector Base Dimensions	Connector Assembly	Components	
			
Item Description	Mould Side Connector	Connector Base	Insert - 24 Pin 16A
Mastip Product Code	79-000-037	29-100-018	29-100-015
Industry Reference Code			
International			
Harting		Han 24B-Base Panel 1 Lever 09 30 024 0307	Han E 24 Pos. F 09 33 024 2701
ILME		CHI 24L	CNEF 24T
Weiland			
Weidmuller		HDC 24B ALU 1213900000	HDC HE 24 FS 1211300000

Mould Side Connectors





12 Zone , 24 Pin - Double Latch			
Male Type			
Connector Base Dimensions	Connector Assembly	Components	
Item Description	Mould Side Connector	Connector Base	Insert - 24 Pin 16A
Mastip Product Code	79-000-038	29-100-329	29-100-012
Industry Reference Code			
International			
Harting		Han B Base Panel 2 Levers 09 30 024 0301	Han E 24 Pos. M 09 33 024 2601
ILME		CHI 24	CNEM 24T
Weiland			
Weidmuller		HDC 24B ABU N 2488600000	HDC HE 24 MS 1211100000
Female Type			
Connector Base Dimensions	Connector Assembly	Components	
Item Description	Mould Side Connector	Connector Base	Insert - 24 Pin 16A
Mastip Product Code	79-000-039	29-100-329	29-100-015
Industry Reference Code			
International			
Harting		Han B Base Panel 2 Levers 09 30 024 0301	Han E 24 Pos. F 09 33 024 2701
ILME		CHI 24	CNEF 24T
Weiland			
Weidmuller		HDC 24B ABU N 2488600000	HDC HE 24 FS 1211300000

Mould Side Connectors



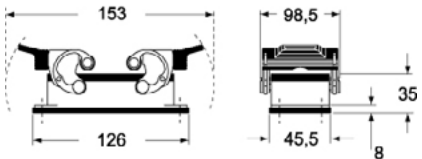

12 Zone , 25 Pin - Single Latch				
Male Type				
Connector Base Dimensions	Connector Assembly	Components		
				
Item Description	Mould Side Connector	Connector Base	Insert - 25 Pin 10A	Pin 1.5mm
Mastip Product Code	79-000-014	29-100-025	29-100-028	29-100-349
Industry Reference Code				
International	PIC-12-G			
Harting		Han 16A-HBM-SL 09 20 016 0301	Han D 25 Pos. M 09 21 025 3001	R 15-STI-C-1,5 09 15 000 6101
ILME		CZI 25L	CDM 25	CDMA1.5
Weiland				
Weidmuller		HDC 16A ALU 1664920000	HDC HD 25 MC 1650810000	HDC-C-HD-SM1.5AG 1651550000
Female Type				
Connector Base Dimensions	Connector Assembly	Components		
				
Item Description		Connector Base	Insert - 25 Pin 10A	Pin 1.5mm
Mastip Product Code		29-100-025	29-100-029	29-100-048
Industry Reference Code				
International				
Harting		Han 16A-HBM-SL 09 20 016 0301	Han D 25 Pos.F 09 21 025 3101	Han D F Crimp 09 15 000 6201
ILME		CZI 25L	CDF 25	CDFA 1.5
Weiland				
Weidmuller		HDC 16A ALU 1664920000	HDC HD 25 FC 1650820000	HDC-C-HD-BM1.5AG 1651600000

Mould Side Connectors

16 Zone , 32 Pin 2x16 - Double Latch Connector Base

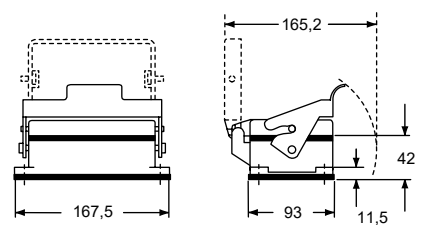
Connector Base Dimensions	Connector Base	Reference Inserts	
			
Item Description	Double Latch Base	Male Insert - 16 Pin 16A	Female Insert - 16 Pin 16A
Mastip Product Code	29-100-401	29-100-011	29-100-014
Industry Reference Code			
International			
Harting		Han E 16 Pos. M 09 33 016 2601	Han 16E-bu-s 09 33 016 2701
ILME	CHI32	CNEM 16T	CNEF 16T
Weiland			
Weidmuller		HDC HE 16 MS 1207500000	HDC HE 16 FS 1207700000

24 Zone , 48 Pin 2x24 - Single Latch Connector Base

Connector Base Dimensions	Connector Base	Reference Inserts	
			
Item Description	Single Latch Base	Male Insert - 24 Pin 16A	Female Insert - 24 Pin 16A
Mastip Product Code	29-100-022	29-100-012	29-100-015
Industry Reference Code			
International			
Harting		Han E 24 Pos. M 09 33 024 2601	Han E 24 Pos. F 09 33 024 2701
ILME	CHI48LS	CNEM 24T	CNEF 24T
Weiland			
Weidmuller		HDC HE 24 MS 1211100000	HDC HE 24 FS 1211300000

Connector Hoods - Top Entry

5 Pin Male Connector Single Latch			
<p>Connector Hood Dimensions</p> 			
Item Description	Connector Assembly	Connector Hood - 5 Pin	Male Insert - 5 Pin 10A
Mastip Product Code	79-000-070	29-100-001	29-100-003
Industry Reference Code			
International	CKPTM-1		
Harting		Han 3A-HTE-PG11 09 20 003 1440	Han 4A-STI-S 09 20 004 2611
ILME		CKA 03 V	CKM 04
Weiland			73.310.0453.0
Weidmuller		HDC 07A TOLU 1M20G 1788520000	HDC HA 4 MS1498300000
5 Pin Female Connector Single Latch			
<p>Connector Hood Dimensions</p> 	Connector Hood	Reference Inserts	
			
Item Description	Connector Assembly	Connector Hood - 5 Pin	Insert - 5 Pin 10A
Mastip Product Code	79-000-071	29-100-001	29-100-004
Industry Reference Code			
International	CKPTF-1		
Harting		Han 3A-HTE-PG11 09 20 003 1440	Han 4A-BU-S 09 20 004 2711
ILME		CKA 03 V	CKF 04
Weiland			73.300.0453.0
Weidmuller		HDC 07A TOLU 1M20G 1788520000	HDC HA 4 FS 1498400000

Connector Hoods - Top Entry

10 Pin Single Latch			
Connector Base Dimensions	Connector Hood	Reference Inserts	
Item Description	Connector Hood - 10 Pin	Male Insert - 10 Pin 16A	Female Insert - 10 Pin 16A
Mastip Product Code	29-100-019	29-100-010	29-100-013
Industry Reference Code			
International			
Harting	Han 10 B Hood Top Entry M20 19 30 010 1440	Han E 10 Pos. M 09 33 010 2601	Han E 10 Pos. F 09 33 010 2701
ILME	MHV 10L 20	CNEM 10T	CNEF 10T
Weiland			
Weidmuller		HDC HE 10 MS 1203900000	HDC HE 10 FS 1204100000

Connector Hoods - Top Entry

16 Pin Single Latch			
Connector Hood Dimensions	Connector Hood	Reference Inserts	
Item Description	Connector Hood - 16 Pin	Insert - 16 Pin 16A	Insert - 16 Pin 16A
Mastip Product Code	29-100-020	29-100-011	29-100-014
Industry Reference Code			
International			
Harting	Han B Hood Top Entry LC 2 Reels M25 19 30 016 1441	Han E 16 Pos. M 09 33 016 2601	Han 16E-bu-s 09 33 016 2701
ILME	MHV 16L 25	CNEM 16T	CNEF 16T
Weiland			
Weidmuller	HDC 16B TOLU 1M25G 1788230000	HDC HE 16 MS 1207500000	HDC HE 16 FS 1207700000
16 Pin Double Latch			
Connector Base Dimensions	Connector Hood	Reference Inserts	
Item Description	Connector Hood - 16 Pin	Insert - 16 Pin 16A	Insert - 16 Pin 16A
Mastip Product Code	29-100-392	29-100-011	29-100-014
Industry Reference Code			
International			
Harting	Han B Hood Top Entry LC 4 Pegs M25 19 30 016 1421	Han E 16 Pos. M 09 33 016 2601	Han 16E-bu-s 09 33 016 2701
ILME	MHV 16.25	CNEM 16T	CNEF 16T
Weiland			
Weidmuller	HDC 16B TOBU 1M25G 1788210000	HDC HE 16 MS 1207500000	HDC HE 16 FS 1207700000

Connector Hoods - Top Entry

16 Pin - Series A Single Latch			
Connector Hood Dimensions	Connector Hood	Reference Inserts	
Item Description	Connector Hood - 16 Pin	Insert - 16 Pin 16A	Insert - 16 Pin 16A
Mastip Product Code	29-100-027	29-100-047	29-100-041
Industry Reference Code			
International			
Harting	Han A Hood Top Entry HC 2 Pegs M25 19 20 016 0446	Han A 16-STI-S 09 20 016 2614	Han A 16-BU-S 09 20 016 2814
ILME	MZAV 25L 25	CDAM 16	CDAF 16
Weiland			
Weidmuller	HDC 16A TOLU 1M25G 1788750000	HDC HA 16 MS 1650770000	HDC HA 16 FS 1650780000

Connector Hoods - Top Entry

24 Pin Single Latch			
Connector Hood Dimensions	Connector Hood	Reference Inserts	
Item Description	Connector Hood - 24 Pin	Insert - 24 Pin 16A	Insert - 24 Pin 16A
Mastip Product Code	29-100-021	29-100-012	29-100-015
Industry Reference Code			
International			
Harting		Han E 24 Pos. M 09 33 024 2601	Han E 24 Pos. F 09 33 024 2701
ILME	MHV 24L 25	CNEM 24T	CNEF 24T
Weiland			
Weidmuller	HDC 24B TOLU 1M25G 1787860000	HDC HE 24 MS 1211100000	HDC HE 24 FS 1211300000
24 Pin Double Latch			
Connector Base Dimensions	Connector Hood	Reference Inserts	
Item Description	Connector Hood - 24 Pin	Insert - 24 Pin 16A	Insert - 24 Pin 16A
Mastip Product Code	29-100-360	29-100-012	29-100-015
Industry Reference Code			
International			
Harting		Han E 24 Pos. M 09 33 024 2601	Han E 24 Pos. F 09 33 024 2701
ILME	MHV24.25	CNEM 24T	CNEF 24T
Weiland			
Weidmuller	HDC 24B TOBU 1M25G 1787820000	HDC HE 24 MS 1211100000	HDC HE 24 FS 1211300000

Connector Hoods - Top Entry

25 Pin - Single Latch			
Male Type			
Connector Hood Dimensions	Connector Hood	Reference Male Insert and Pin	
Item Description	Connector Hood - 25 Pin	Insert - 25 Pin 10A	Pin 1.5mm
Mastip Product Code	29-100-027	29-100-028	29-100-349
Industry Reference Code			
International			
Harting	Han A Hood Top Entry HC 2 Pegs M25 19 20 016 0446	Han D 25 Pos. M 09 21 025 3001	R 15-STI-C-1,5 09 15 000 6101
ILME	MZAV 25L 25	CDM 25	CDMA1.5
Weiland			
Weidmuller	HDC 16A TOLU 1M25G 1788750000	HDC HD 25 MC 1650810000	HDC-C-HD-SM1.5AG 1651550000
Female Type			
Connector Hood Dimensions	Connector Hood	Reference Female Insert and Pin	
Item Description	Connector Hood - 25 Pin	Insert - 25 Pin 10A	Pin 1.5mm
Mastip Product Code	29-100-027	29-100-029	29-100-048
Industry Reference Code			
International			
Harting	Han A Hood Top Entry HC 2 Pegs M25 19 20 016 0446	Han D 25 Pos.F 09 21 025 3101	Han D F Crimp 09 15 000 6201
ILME	MZAV 25L 25	CDF 25	CDFA 1.5
Weiland			
Weidmuller	HDC 16A TOLU 1M25G 1788750000	HDC HD 25 FC 1650820000	HDC-C-HD-BM1.5AG 1651600000

Cable Gland

Gland M25 D13-18

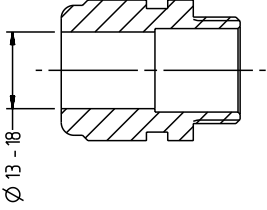
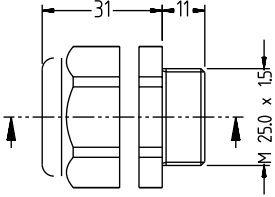
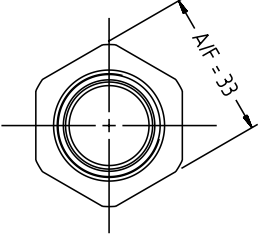
Gland	Mastip Code	Dimensions		
	<p>29-100-313</p>	 <p>Ø 13 - 18</p>	 <p>31 11 M 25.0 x 15</p>	 <p>A/F = 33</p>
<p>* The Gland can be used for 10 Pin to 25 Pin connector hoods listed on page 14 - 18</p>				

Modular Terminal Mounting Box

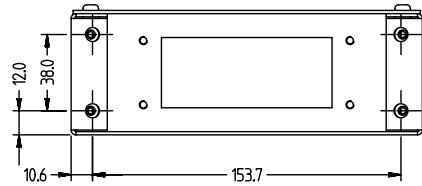
Mastip Code	Rows	Pin	Box Dimension	Screws Distance
79-010-501	1	1 x 5 Pin	L175 x W62 x H65	
79-010-502	1	2 x 5 Pin		
79-010-508	1	1 x 16 Pin		
79-010-512	1	1 x 24 Pin		

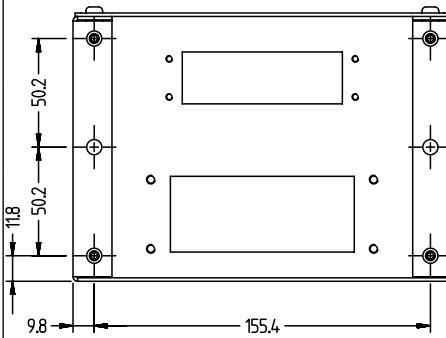

Mastip Code	Rows	Pin	Box Dimension	Screws Distance
79-010-608	2	2 x 16 Pin	L175 x W124 x H65	
79-010-609	2	1 x 16 Pin, 1 x 25 Pin		
79-010-612	2	2 x 24 Pin		
79-010-613	2	1 x 24 Pin, 1 x 25 Pin		

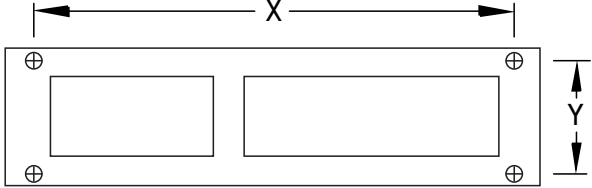

USA Style Terminal Mounting Box

Mastip Code	International Code	Pin	Box Dimension L x W x H (mm/US inch)	Screws Distance (mm/US inch)	
				X	Y
79-010-701	PTC5TB	1 x 25 Pin, 1 x 10 Pin	220 x 70 x 108mm/ 8.66 x 2.75 x 4.25in	204mm/ 8.031in	38mm/ 1.5in
79-010-702	PTC8TC	1 x 25 Pin, 1 x 16 Pin	240.5 x 70 x 108mm/ 9.47 x 2.75 x 4.25in	224.6mm/ 8.843in	38mm/ 1.5in
79-010-703	PTC12TB	1 x 25 Pin, 1 x 24 Pin	267.5 x 70 x 108mm/ 10.53 x 2.75 x 4.25in	251.6mm/ 9.906in	38mm/ 1.5in
			 <p>Mould Mounting Footprint</p>		

* Other options are available on request.

Die Cast Terminal Mounting Box

Mastip Code	Rows	Pin	Box Dimension (L x W x H)	Screws Distance
79-010-801	1	1 x 16 Pin or 1 x 12 Pin	170 x 48 x 59 mm	156 mm



Mastip Code	Rows	Pin	Box Dimension (L x W x H)	Screws Distance
79-010-802	2	2 x 16 Pin or 2 x 12 Pin	151 x 14 x 59 mm	134 mm



Temperature Controller Cables

Power Cable

	Max. Zones	Connector Type		Mastip Product Code
		Controller Side	Mold Side	
	5	25 Pin Male - Single Latch	25 Pin Female - Single Latch	79-075-050
	8	16 Pin Male - Double Latch	16 Pin Female - Double Latch	79-075-080
	8	16 Pin Male - Double Latch	25 Pin Female Single Latch	79-075-082
	8	16 Pin Male - Single Latch	16 Pin Female Single Latch	79-075-084
	8	16 Pin Male - Single Latch	25 Pin Female Single Latch	79-075-086
	8	25 Pin Male - Single Latch	25 Pin Female - Single Latch	79-075-088
	12	24 Pin Male - Double Latch	24 Pin Female - Double Latch	79-075-120
	12	24 Pin Male - Double Latch	25 Pin Female - Single Latch	79-075-122
	12	24 Pin Male - Single Latch	24 Pin Female - Single Latch	79-075-124
	12	24 Pin Male - Single Latch	25 Pin Female - Single Latch	79-075-126
	12	25 Pin Male - Single Latch	25 Pin Female - Single Latch	79-075-128

* Cable Length: 3 meters

* Alternative length can be supplied

Temperature Controller Cables

Thermocouple Cable



Max. Zones	Connector Type		Mastip Product Code
	Controller Side	Mold Side	
5	25 Pin Female - Single Latch	10 Pin Female - Single Latch	79-075-051
8	16 Pin Female - Double Latch	16 Pin Male - Double Latch	79-075-081
8	16 Pin Female - Double Latch	16 Pin Female - Single Latch	79-075-083
8	16 Pin Female - Single Latch	16 Pin Female - Single Latch	79-075-087
8	25 Pin Female - Single Latch	16 Pin Female - Single Latch	79-075-089
12	24 Pin Female - Double Latch	24 Pin Male - Double Latch	79-075-121
12	24 Pin Female - Double Latch	24 Pin Female - Single Latch	79-075-123
12	24 Pin Female - Single Latch	24 Pin Female - Single Latch	79-075-127
12	25 Pin Female - Single Latch	24 Pin Female - Single Latch	79-075-129

* Cable Length: 3 meters

* Alternative length can be supplied

Power & Thermocouple Combination Cable



Max. Zones	Connector Type		Mastip Product Code
	Controller Side	Mold Side	
1	5 Pin Male Single Latch	5 Pin Female Single Latch	79-075-010
4	16 Pin Male Double Latch	16 Pin Female Double Latch	79-075-040
4	16 Pin Male Single Latch	16 Pin Female Single Latch	79-075-041

* Cable Length: 3 meters

* Alternative length can be supplied

Integrated Controller



No. of Zones	Description	Mastip Code	Power Input	Output Connector	
				Power Connector	TC Connector
1	CIS - 1	79-060-010	230V 1P	1 x 5 Pin Female Single Latch, Power & TC Combination	
2	CIS - 2	79-060-020		2 x 5 Pin Female Single Latch, Power & TC Combination	

* Dimension : 193 x 71 x 225mm

* See user guides for features and operating instruction. [\[Click for User Guides\]](#)

Modules



Mastip Code	Description	Display
79-074-001	TM10	LED

Mastip Code	Description	Display	Option
79-074-002	TM20	LCD	RS485 communication

*Compatible with most leading hot runner controller brands

*See user guides for features and operating instruction. [\[Click for User Guides\]](#)

European Style Modular Mainframe - Rear Mounted Connectors



2 Zones Mainframe

Mastip Code	Description	Power Input	Output Connector	
			Power Connector	TC Connector
79-071-020	MFE - 2	415V 3P Star	1 x 16 Pin Female Double Latch, Power & TC Combination	
79-071-021			1 x 16 Pin Female Single Latch, Power & TC Combination	

* Dimension: 183 x 201 x 291mm

European Style Modular Mainframe - Rear Mounted Connectors

4 Zones Mainframe

Mastip Code	Description	Power Input	Output Connector	
			Power Connector	TC Connector
79-071-040	MFE - 4	415V 3P Star	1 x 16 Pin Female Double Latch, Power & TC Combination	
79-071-041			1 x 16 Pin Female Single Latch, Power & TC Combination	
79-071-042			1 x 25 Pin Female - Single Latch	1 x 25 Pin Male - Single Latch

* Dimension: 310 x 212 x 291mm

6 Zones Mainframe

Mastip Code	Description	Power Input	Output Connector	
			Power Connector	TC Connector
79-071-060	MFE - 6	415V 3P Star	1 x 16 Pin Female - Double Latch	1 x 16 Pin Male - Double Latch
79-071-061			1 x 16 Pin Female - Single Latch	1 x 16 Pin Male - Single Latch

* Dimension: 411 x 212 x 291mm

8 Zones Mainframe

Mastip Code	Description	Power Input	Output Connector	
			Power Connector	TC Connector
79-071-080	MFE - 8	415V 3P Star	1 x 16 Pin Female - Double Latch	1 x 16 Pin Male - Double Latch
79-071-081			1 x 16 Pin Female - Single Latch	1 x 16 Pin Male - Single Latch

* Dimension: 512 x 212 x 291mm

European Style Modular Mainframe - Rear Mounted Connectors

12 Zones Mainframe

Mastip Code	Description	Power Input	Output Connector	
			Power Connector	TC Connector
79-071-120	MFE - 12	415V 3P Star	1 x 24 Pin Female - Double Latch	1 x 24 Pin Male - Double Latch
79-071-121			1 x 24 Pin Female - Single Latch	1 x 24 Pin Male - Single Latch

* Dimension: 714 x 212 x 291mm

USA Style Modular Mainframe - Side Mounted Connectors



5 Zones Mainframe

Mastip Code	Description	Power Input	Output Connector	
			Power Connector	TC Connector
79-072-050	MFU - 5	415V 3P Star	1 x 25 Pin Female - Single Latch	1 x 25 Pin Male - Single Latch
79-072-051		220V 3P Delta	1 x 25 Pin Female - Single Latch	1 x 25 Pin Male - Single Latch

* Dimension: 410 x 214 x 324 mm / 16.14 x 8.43 x 12.76in

USA Style Modular Mainframe - Side Mounted Connectors

8 Zones Mainframe

Mastip Code	Description	Power Input	Output Connector	
			Power Connector	TC Connector
79-072-080	MFU - 8	415V 3P Star	1 x 25 Pin Female - Single Latch	1 x 25 Pin Male - Single Latch
79-072-081		220V 3P Delta	1 x 25 Pin Female - Single Latch	1 x 25 Pin Male - Single Latch

* Dimension: 563 x 214 x 324 mm / 22.17 x 8.43 x 12.76in

12 Zones Mainframe

Mastip Code	Description	Power Input	Output Connector	
			Power Connector	TC Connector
79-072-120	MFU - 12	415V 3P Star	1 x 25 Pin Female - Single Latch	1 x 25 Pin Male - Single Latch
79-072-121		220V 3P Delta	1 x 25 Pin Female - Single Latch	1 x 25 Pin Male - Single Latch

* Dimension: 766 x 214 x 324 mm / 30.16 x 8.43 x 12.76in

European Style Modular Controller - Rear Mounted Connectors



2 Zones Controller

Mastip Code	Description	Module	Power Input	Output Connector	
				Power Connector	TC Connector
79-061-020	CM10E - 2	TM10 - LED	415V 3P Star	1 x 16 Pin Female Double Latch, Power & TC Combination	
79-061-021				1 x 16 Pin Female Single Latch, Power & TC Combination	
79-061-023	CM20E - 2	TM20 - LCD		1 x 16 Pin Female Double Latch, Power & TC Combination	
79-061-024				1 x 16 Pin Female Single Latch, Power & TC Combination	

* Dimension: 183 x 201 x 291mm

4 Zones Controller

Mastip Code	Description	Module	Power Input	Output Connector	
				Power Connector	TC Connector
79-061-040	CM10E - 4	TM10 - LED	415V 3P Star	1 x 16 Pin Female Double Latch, Power & TC Combination	
79-061-041				1 x 16 Pin Female Single Latch, Power & TC Combination	
79-061-042				1 x 25 Pin Female - Single Latch	1 x 25 Pin Male - Single Latch
79-061-043	CM20E - 4	TM20 - LCD		1 x 16 Pin Female Double Latch, Power & TC Combination	
79-061-044				1 x 16 Pin Female Single Latch, Power & TC Combination	
79-061-045				1 x 25 Pin Female - Single Latch	1 x 25 Pin Male - Single Latch

* Dimension: 310 x 212 x 291mm

European Style Modular Controller - Rear Mounted Connectors

6 Zones Controller

Mastip Code	Description	Module	Power Input	Output Connector	
				Power Connector	TC Connector
79-061-060	CM10E - 6	TM10 - LED	415V 3P Star	1 x 16 Pin Female - Double Latch	1 x 16 Pin Male - Double Latch
79-061-061				1 x 16 Pin Female - Single Latch	1 x 16 Pin Male - Single Latch
79-061-063	CM20E - 6	TM20 - LCD		1 x 16 Pin Female - Double Latch	1 x 16 Pin Male - Double Latch
79-061-064				1 x 16 Pin Female - Single Latch	1 x 16 Pin Male - Single Latch

* Dimension: 411 x 212 x 291mm

8 Zones Controller

Mastip Code	Description	Module	Power Input	Output Connector	
				Power Connector	TC Connector
79-061-080	CM10E - 8	TM10 - LED	415V 3P Star	1 x 16 Pin Female - Double Latch	1 x 16 Pin Male - Double Latch
79-061-081				1 x 16 Pin Female - Single Latch	1 x 16 Pin Male - Single Latch
79-061-083	CM20E - 8	TM20 - LCD		1 x 16 Pin Female - Double Latch	1 x 16 Pin Male - Double Latch
79-061-084				1 x 16 Pin Female - Single Latch	1 x 16 Pin Male - Single Latch

* Dimension: 512 x 212 x 291mm

12 Zones Controller

Mastip Code	Description	Module	Power Input	Output Connector	
				Power Connector	TC Connector
79-061-120	CM10E - 12	TM10 - LED	415V 3P Star	1 x 24 Pin Female - Double Latch	1 x 24 Pin Male - Double Latch
79-061-121				1 x 24 Pin Female - Single Latch	1 x 24 Pin Male - Single Latch
79-061-123	CM20E - 12	TM20 - LCD		1 x 24 Pin Female - Double Latch	1 x 24 Pin Male - Double Latch
79-061-124				1 x 24 Pin Female - Single Latch	1 x 24 Pin Male - Single Latch

* Dimension: 714 x 212 x 291mm

* See user guides for features and operating instruction. [\[Click for User Guides\]](#)

USA Style Modular Controller - Side Mounted Connectors



5 Zones Controller

Mastip Code	Description	Module	Power Input	Output Connector	
				Power Connector	TC Connector
79-062-050	CM10U - 5	TM10 - LED	415V 3P Star	1 x 25 Pin Female - Single Latch	1 x 25 Pin Male - Single Latch
79-062-051	CM20U - 5	TM20 - LCD		1 x 25 Pin Female - Single Latch	1 x 25 Pin Male - Single Latch
79-062-052	CM10U - 5	TM10 - LED	220V 3P Delta	1 x 25 Pin Female - Single Latch	1 x 25 Pin Male - Single Latch
79-062-053	CM20U - 5	TM20 - LCD		1 x 25 Pin Female - Single Latch	1 x 25 Pin Male - Single Latch

* Dimension: 410 x 214 x 324 mm / 16.14 x 8.43 x 12.76in

8 Zones Controller

Mastip Code	Description	Module	Power Input	Output Connector	
				Power Connector	TC Connector
79-062-080	CM10U - 8	TM10 - LED	415V 3P Star	1 x 25 Pin Female - Single Latch	1 x 25 Pin Male - Single Latch
79-062-081	CM20U - 8	TM20 - LCD		1 x 25 Pin Female - Single Latch	1 x 25 Pin Male - Single Latch
79-062-082	CM10U - 8	TM10 - LED	220V 3P Delta	1 x 25 Pin Female - Single Latch	1 x 25 Pin Male - Single Latch
79-062-083	CM20U - 8	TM20 - LCD		1 x 25 Pin Female - Single Latch	1 x 25 Pin Male - Single Latch

* Dimension: 563 x 214 x 324 mm / 22.17 x 8.43 x 12.76in

12 Zones Controller

Mastip Code	Description	Module	Power Input	Output Connector	
				Power Connector	TC Connector
79-062-120	CM10U - 12	TM10 - LED	415V 3P Star	1 x 25 Pin Female - Single Latch	1 x 25 Pin Male - Single Latch
79-062-121	CM20U - 12	TM20 - LCD		1 x 25 Pin Female - Single Latch	1 x 25 Pin Male - Single Latch
79-062-122	CM10U - 12	TM10 - LED	220V 3P Delta	1 x 25 Pin Female - Single Latch	1 x 25 Pin Male - Single Latch
79-062-123	CM20U - 12	TM20 - LCD		1 x 25 Pin Female - Single Latch	1 x 25 Pin Male - Single Latch

* Dimension: 766 x 214 x 324 mm / 30.16 x 8.43 x 12.76in

* See user guides for features and operating instruction. [\[Click for User Guides\]](#)

Touch Screen Temperature Controller - CTI-100



12 Zones Controller (7" Touch Screen)

Mastip Code	Description	Power Input	Output Connector	
			Power Connector	TC Connector
79-063-120	CTI-100 - 12 zone + 7"	415V 3P Star	1 x 24 Pin Female - Double Latch	1 x 24 Pin Male - Double Latch
79-063-121			1 x 24 Pin Female - Single Latch	1 x 24 Pin Male - Single Latch
79-063-122			1 x 25 Pin Female - Single Latch	1 x 25 Pin Male - Single Latch
79-063-123		220V 3P Delta	1 x 25 Pin Female - Single Latch	1 x 25 Pin Male - Single Latch

* Dimension: 411 x 395 x 291mm

24 Zones Controller (7" Touch Screen)

Mastip Code	Description	Power Input	Output Connector	
			Power Connector	TC Connector
79-063-240	CTI-100 - 24 zone + 7"	415V 3P Star	2 x 24 Pin Female - Double Latch	2 x 24 Pin Male - Double Latch
79-063-241			2 x 24 Pin Female - Single Latch	2 x 24 Pin Male - Single Latch
79-063-242			2 x 25 Pin Female - Single Latch	2 x 25 Pin Male - Single Latch
79-063-243		220V 3P Delta	2 x 25 Pin Female - Single Latch	2 x 25 Pin Male - Single Latch

* Dimension: 411 x 590 x 291mm

* See user guides for features and operating instruction. [\[Click for User Guides\]](#)

Touch Screen Temperature Controller - CTI-200



32 Zones Controller (10" Touch Screen)

Mastip Code	Description	Power Input	Output Connector	
			Power Connector	TC Connector
79-064-320	CTI-200 - 32 zone + 10"	415V 3P Star	3 x 24 Pin Female - Double Latch	3 x 24 Pin Male - Double Latch
79-064-321			3 x 24 Pin Female - Single Latch	3 x 24 Pin Male - Single Latch
79-064-322			3 x 25 Pin Female - Single Latch	3 x 25 Pin Male - Single Latch
79-064-323		220V 3P Delta	3 x 25 Pin Female - Single Latch	3 x 25 Pin Male - Single Latch

* Dimension: 465 x 1150 x 340mm

48 Zones Controller (10" Touch Screen)

Mastip Code	Description	Power Input	Output Connector	
			Power Connector	TC Connector
79-064-480	CTI-200 - 48 zone + 10"	415V 3P Star	4 x 24 Pin Female - Double Latch	4 x 24 Pin Male - Double Latch
79-064-481			4 x 24 Pin Female - Single Latch	4 x 24 Pin Male - Single Latch
79-064-482			4 x 25 Pin Female - Single Latch	4 x 25 Pin Male - Single Latch
79-064-483		220V 3P Delta	4 x 25 Pin Female - Single Latch	4 x 25 Pin Male - Single Latch

* Dimension: 465 x 1150 x 340mm

Touch Screen Temperature Controller- CTI-200

64 Zones Controller (10" Touch Screen)

Mastip Code	Description	Power Input	Output Connector	
			Power Connector	TC Connector
79-064-640	CTI-200 - 64 zone + 10"	415V 3P Star	6 x 24 Pin Female - Double Latch	6 x 24 Pin Male - Double Latch
79-064-641			6 x 24 Pin Female - Single Latch	6 x 24 Pin Male - Single Latch
79-064-642			6 x 25 Pin Female - Single Latch	6 x 25 Pin Male - Single Latch
79-064-643		220V 3P Delta	6 x 25 Pin Female - Single Latch	6 x 25 Pin Male - Single Latch

* Dimension: 465 x 1150 x 340mm

80 Zones Controller (10" Touch Screen)

Mastip Code	Description	Power Input	Output Connector	
			Power Connector	TC Connector
79-065-800	CTI-200 - 80 zone + 10"	415V 3P Star	7 x 24 Pin Female - Double Latch	7 x 24 Pin Male - Double Latch
79-065-801			7 x 24 Pin Female - Single Latch	7 x 24 Pin Male - Single Latch
79-065-802			7 x 25 Pin Female - Single Latch	7 x 25 Pin Male - Single Latch
79-065-803		220V 3P Delta	7 x 25 Pin Female - Single Latch	7 x 25 Pin Male - Single Latch

* Dimension: 465 x 1345 x 340 mm

* See user guides for features and operating instruction. [\[Click for User Guides\]](#)

Touch Screen Temperature Controller- CTI-300



96 Zones Controller (10" Touch Screen)

Mastip Code	Description	Power Input	Output Connector	
			Power Connector	TC Connector
79-065-960	CTI-300 - 96 zone + 10"	415V 3P Star	8 x 24 Pin Female - Double Latch	8 x 24 Pin Male - Double Latch
79-065-961			8 x 24 Pin Female - Single Latch	8 x 24 Pin Male - Single Latch
79-065-962			8 x 25 Pin Female - Single Latch	8 x 25 Pin Male - Single Latch
79-065-963		220V 3P Delta	8 x 25 Pin Female - Single Latch	8 x 25 Pin Male - Single Latch

* Dimension: 566 x 1345 x 340 mm

Touch Screen Temperature Controller- CTI-300

120 Zones Controller (10" Touch Screen)

Mastip Code	Description	Power Input	Output Connector	
			Power Connector	TC Connector
79-065-120	CTI-300 - 120 zone + 10"	415V 3P Star	10 x 24 Pin Female - Double Latch	10 x 24 Pin Male - Double Latch
79-065-121			10 x 24 Pin Female - Single Latch	10 x 24 Pin Male - Single Latch
79-065-122			10 x 25 Pin Female - Single Latch	10 x 25 Pin Male - Single Latch
79-065-123		220V 3P Delta	10 x 25 Pin Female - Single Latch	10 x 25 Pin Male - Single Latch

Dimension: Touch Screen Folded - 527 x 1090 x 458 mm ; Touch Screen Unfolded - 527 x 1340 x 458 mm

* See user guides for features and operating instruction. [\[Click for User Guides\]](#)

Temperature Controller TC5100/5200

TC 5100 Controller



No. of Zones	Dimension (mm) L x W x H	Mastip Code	Power Input	Output Connector	
				Power Connector	TC Connector
12	330 x 380 x 418	79-051-012	415V 3P Star	1 x 24 Pin Female Double Latch	1 x 24 Pin Male Double Latch
		79-051-512	220V 3P Delta		
24	330 x 380 x 573	79-051-024	415V 3P Star	2 x 24 Pin Female Double Latch	2 x 24 Pin Male Double Latch
		79-051-524	220V 3P Delta		
36	330 x 380 x 728	79-051-036	415V 3P Star	3 x 24 Pin Female Double Latch	3 x 24 Pin Male Double Latch
		79-051-536	220V 3P Delta		

TC 5200 Controller



No. of Zones	Dimension (mm) L x W x H	Mastip Code	Power Input	Output Connector	
				Power Connector	TC Connector
36	330 x 520 x 875	79-052-036	415V 3P Star	3 x 24 Pin Female Double Latch	3 x 24 Pin Male Double Latch
		79-052-536	220V 3P Delta		
48	330 x 520 x 1030	79-052-048	415V 3P Star	4 x 24 Pin Female Double Latch	4 x 24 Pin Male Double Latch
		79-052-548	220V 3P Delta		
60	330 x 520 x 1190	79-052-060	415V 3P Star	5 x 24 Pin Female Double Latch	5 x 24 Pin Male Double Latch
		79-052-560	220V 3P Delta		
72	330 x 520 x 1338	79-052-072	415V 3P Star	6 x 24 Pin Female Double Latch	6 x 24 Pin Male Double Latch
		79-052-572	220V 3P Delta		
96	666 x 520 x 1061	79-052-096	415V 3P Star	8 x 24 Pin Female Double Latch	8 x 24 Pin Male Double Latch
		79-052-596	220V 3P Delta		
120	666 x 520 x 1216	79-052-020	415V 3P Star	10 x 24 Pin Female Double Latch	10 x 24 Pin Male Double Latch
		79-052-520	220V 3P Delta		

Sequential Controller

GVT8 Integrated Sequential Controller

GTV 8	Actuation	No. of Zones	Dimension (mm) L x W x H	Mastip Code	Description
	Pneumatic Only	8 Zone	260 x 60 x 200	99-100-098	Sequential Controller GTV8, 220VAC Mains 3m Cables 16 Pin Series A
				99-100-099	Sequential Controller GTV8, 220VAC Mains 5m Cables 16 Pin Series E

GV24 Modular Sequential Controller

GV24	Actuation	No. of Zones	Dimension (mm) L x W x H	Mastip Code	Description
	Pneumatic/ Hydraulic	2 Zone	185 x 350 x 225	99-100-022	Sequential Controller GV24, 220VAC Mains 3m Cables 16 Pin Series A
		3 Zone	235 x 350 x 225	99-100-023	
		4 Zone	285 x 350 x 225	99-100-024	
		5 Zone	335 x 350 x 225	99-100-025	
		6 Zone	385 x 350 x 225	99-100-026	
		7 Zone	435 x 350 x 225	99-100-027	
		8 Zone	485 x 350 x 225	99-100-028	

GV 24 Sequential Controller Cable

	Max. Zones	Mastip Code	Description
	8	79-002-000	Cable Set for Sequential Controller GV24 Output to solenoid valve - 16Pin A Single Latch

Solenoid Pack for Pneumatic Sequential Valve

Solenoid Packs for Pneumatic Sequential Valve

No. of Zones	Mastip Code	Dimensions (mm)			
		Air Input \varnothing	C	D	E
2 Zone	99-100-102	$\varnothing 8.0$	42	61	90
3 Zone	99-100-103		58	77	106
4 Zone	99-100-104		74	93	122
5 Zone	99-100-105	$\varnothing 10.0$	90	109	144
6 Zone	99-100-106		106	125	164
7 Zone	99-100-107		122	141	176
8 Zone	99-100-108		138	157	192

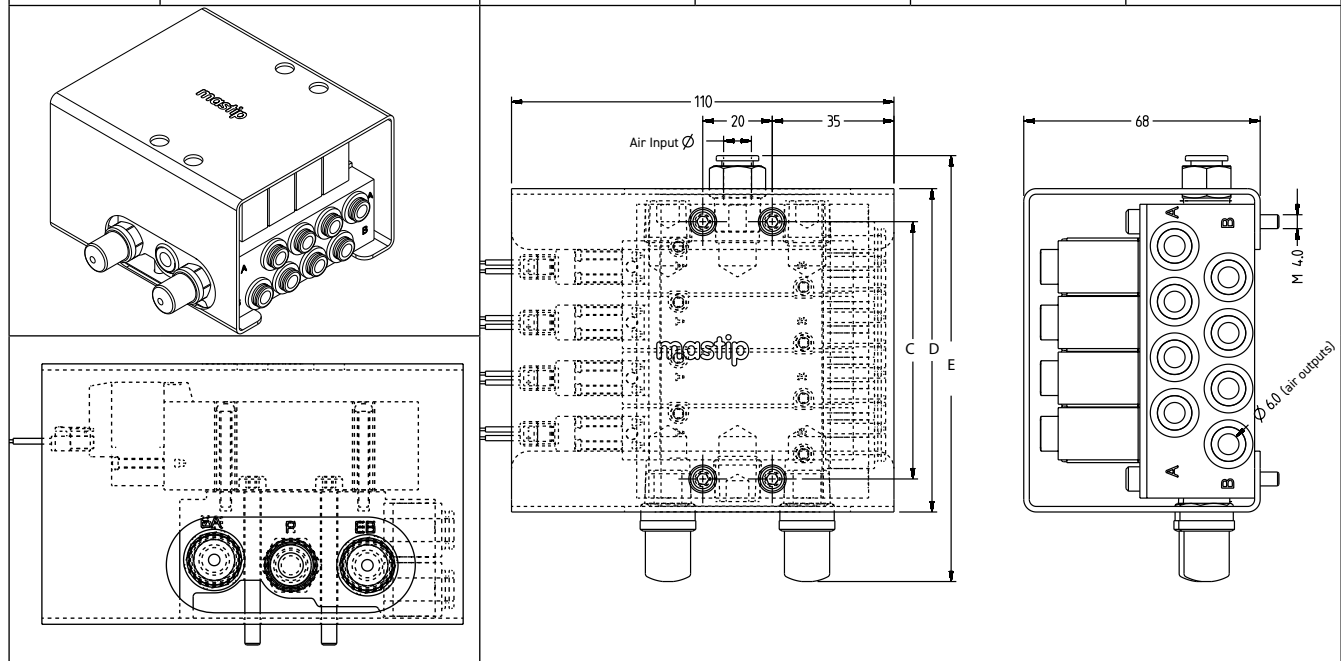

Spare Parts



TC5H Controller Module



Fast Acting Ceramic Fuse



Blank Panel



Module Retaining Screw



Wire Clamps

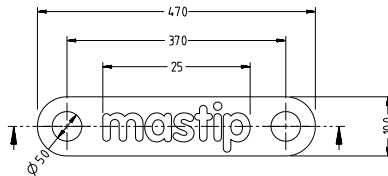

51-001-000

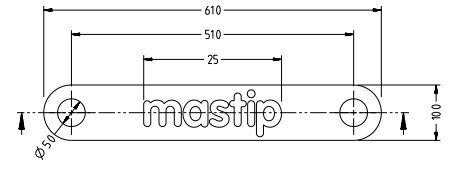

51-001-001

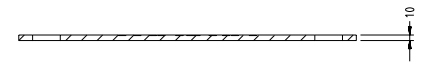
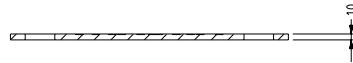

Mastip Product Code	Description
79-003-004	Module Temperature Controller TC5H
79-053-001	TC5100/5200 Control Module 2 Zone
79-053-002	TC5100/5200 BUS Board
79-053-003	TC5100/5200 Over Voltage Protection Board
79-053-004	TC5100/5200 Communication Alarm Board
T-ABC15	Fuse Ceramic Fast Acting D6.3x32mm 15A 250VAC
79-079-001	Blank Panel for Module TM10 & TM20
79-079-002	Module Retaining Screw
51-001-000	Wire Clamp (Holes Distance: 37mm)
51-001-001	Wire Clamp (Holes Distance: 51mm)

Floor Stand for USA Style Modular Controller



Mastip Product Code	Description
79-079-003	Floor Stand for MFU Controllers

* Fit for 5, 8, 12 Zone MFU (USA Style Modular) Controllers Only.

Nozzle Heaters

SX Sprue Heater

Mastip Code	Inner Dia (mm)	Outer Dia (mm)	Length (mm)	Watts
SX24H	24.4	29.3	22.0	250
SX30H	30.0	35.0	22.5	290

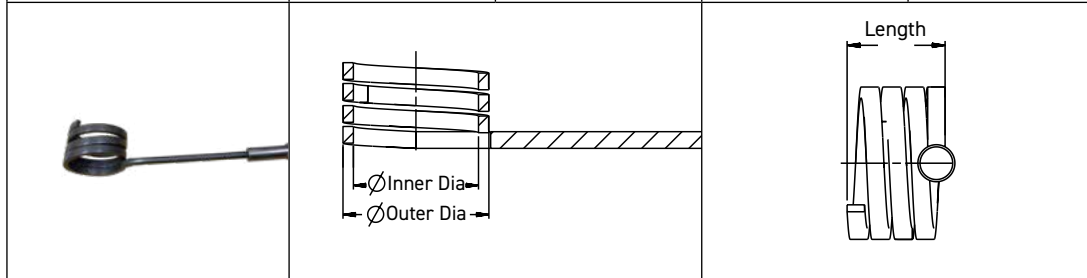

* Supplied with 2m cable

BX/SX 13 Series Nozzle Heater

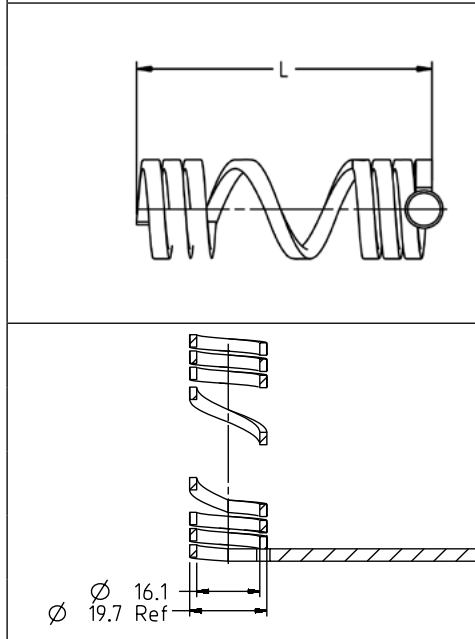

	Mastip Code	Inner Dia (mm)	Outer Dia (mm)	Length (mm)	Watts
	X13045H	16.1	19.7	38.8	220
X13055H	48.8			230	
X13065H	58.8			240	
X13075H	68.8			250	
X13085H	78.8			260	
X13095H	88.8			275	
X13105H	98.8			275	
X13115H	108.8			300	
X13130H	123.8			300	
X13145H	138.8			330	
X13160H	153.8			330	
X13175H	168.8			365	
X13200H	193.8			385	
X13225H	218.8			400	



* Supplied with 2m cable

Nozzle Heaters

BX/SX 16 Series Nozzle Heater

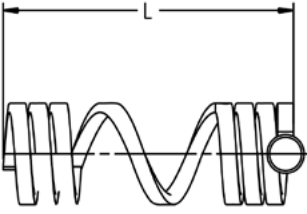
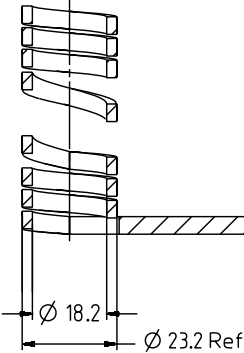
	Mastip Code	Inner Dia (mm)	Outer Dia (mm)	Length (mm)	Watts
	X16045H	18.2	23.2	36.0	290
	X16055H			46.0	310
	X16065H			56.0	335
	X16075H			66.0	360
	X16085H			76.0	360
	X16095H			86.0	385
	X16105H			96.0	385
	X16115H			106.0	410
	X16130H			121.0	425
	X16145H			136.0	440
	X16160H			151.0	440
	X16175H			166.0	475
	X16200H			191.0	485
	X16225H			216.0	500
	X16250H			241.0	520
	X16250H	241.0	520		

* Supplied with 2m cable

Nozzle Heaters

BX/SX 19 Series Nozzle Heater

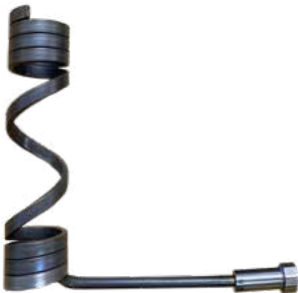
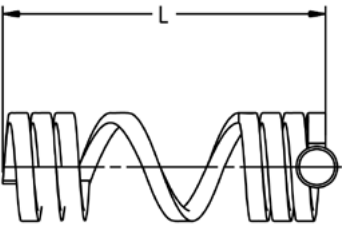
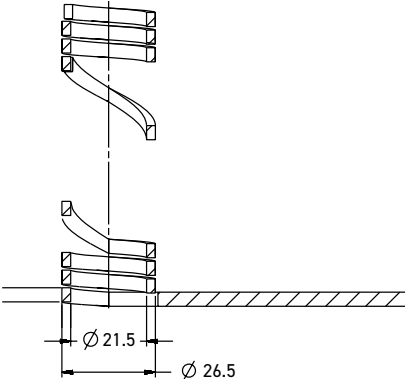
	Mastip Code	Inner Dia (mm)	Outer Dia (mm)	Length (mm)	Watts
	X19045H	21.5	26.5	35.3	400
	X19055H			45.3	400
	X19065H			55.3	435
	X19075H			65.3	470
	X19085H			75.3	470
	X19095H			85.3	505
X19105H	95.3			505	
X19115H	105.3			540	
X19130H	120.3			555	
X19145H	135.3			575	
X19160H	150.3			575	
X19175H	165.3			610	
X19200H	190.3			650	
X19225H	215.3			650	
X19250H	240.3			690	
X19275H	265.3	690			
X19300H	290.3	780			

* Supplied with 2m cable

Nozzle Heaters

BX(Imperial) X25 Series Nozzle Heaters

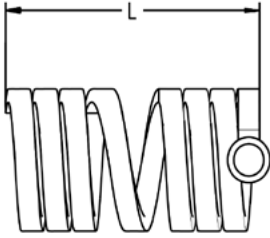
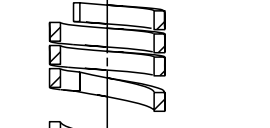
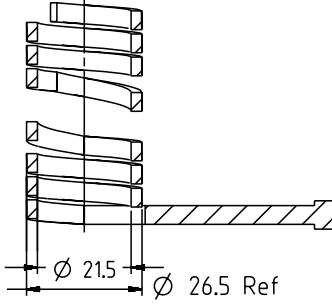
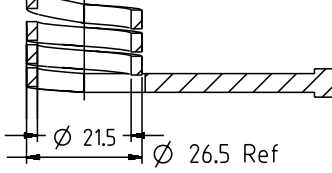
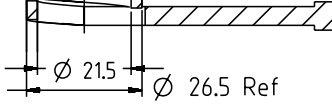
	Mastip Code	Inner Dia (mm)	Outer Dia (mm)	Length (mm)	Wats
	X25137H	21.5 (²⁷ / ₃₂ ")	26.5 (1 ³ / ₆₄ ")	25.4 (1")	295
	X25187H			38.1 (1½")	350
	X25237H			50.8 (2")	455
	X25287H			63.5 (2½")	490
	X25337H			76.2 (3")	505

* Supplied with 2m cable

Nozzle Heaters

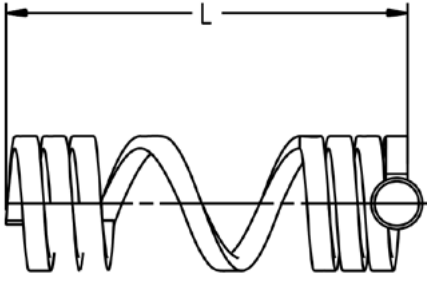
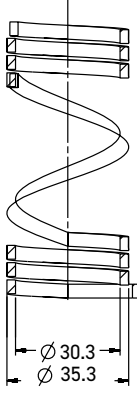

BX/SX 27 Series Nozzle Heater

	Mastip Code	Inner Dia (mm)	Outer Dia (mm)	Length (mm)	Watts
	X27075H	30.3	35.3	60.0	570
	X27085H			70.0	570
	X27095H			80.0	680
	X27105H			90.0	680
	X27115H			100.0	780
	X27130H			115.0	780
	X27145H			130.0	815
	X27160H			145.0	815
	X27175H			160.0	850
	X27200H			185.0	850
	X27225H			210.0	905
				X27250H	235.0
X27275H				260.0	960
X27300H				285.0	870
X27350H				335.0	870
X27400H				385.0	960
X27450H				435.0	1050

* Supplied with 2m cable

Nozzle Heaters

MJ Nozzle Heaters

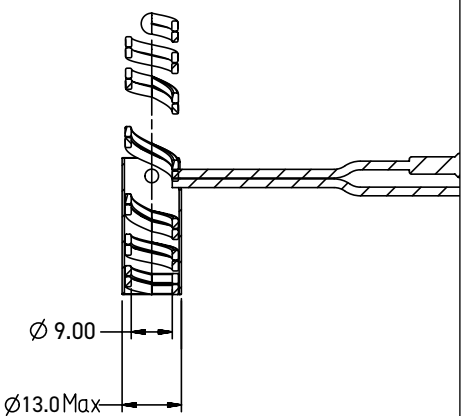
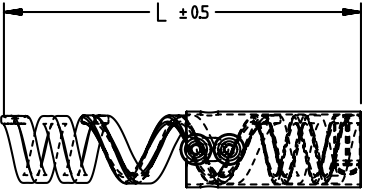
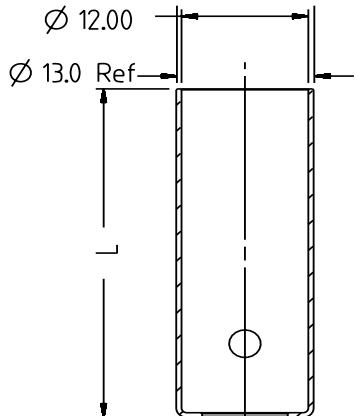
							
MJ Nozzle Heater Assembly		MJ Nozzle Heater		MJ Heater Front Cover			
Mastip Code	Heater				Front Cover		
	Inner Dia (mm)	Outer Dia (mm)	Heater Length (mm)	Watts	Inner Dia (mm)	Outer Dia (mm)	Front Cover Length(mm)
82-109-075	9.00	13.00	59.5	200	12.00	13.0	35.7
82-109-095			79.5	230			55.7
82-109-115			99.5	265			75.7
82-109-130			114.5	295			90.7
82-109-145			129.5	320			105.7
82-109-175			159.5	370			135.7
							

* Supplied with 2m cable

Nozzle Heaters

MX 13 Series Nozzle Heaters

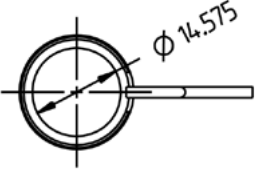
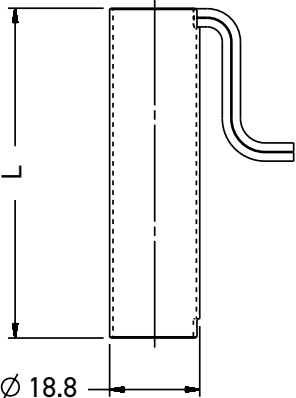
	Mastip Code	Inner Dia (mm)	Outer Dia (mm)	Length (mm)	Watts		
	MX13045HFS	14.575	18.8	38.8	225		
	MX13055HFS			48.8	250		
	MX13065HFS			58.8	250		
MX13075HFS	68.8			290			
MX13095HFS	88.8			330			
	MX13115HFS			14.575	18.8	108.8	400
	MX13130HFS					123.8	470
	MX13145HFS					138.8	470
	MX13175HFS					168.8	550

* Supplied with 2m cable

Nozzle Heaters

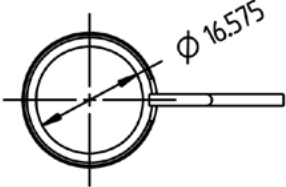
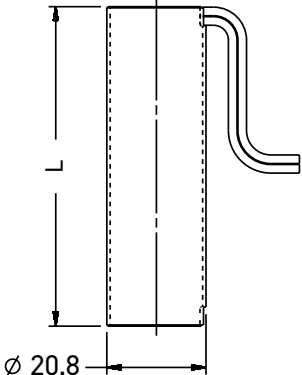

MX 16 Series Nozzle Heaters

	Mastip Code	Inner Dia (mm)	Outer Dia (mm)	Length (mm)	Watts
	MX16045HFS	16.575	20.8	37	290
	MX16055HFS			47	330
	MX16065HFS			57	330
	MX16075HFS			67	400
	MX16095HFS			87	470
	MX16115HFS			107	550
	MX16130HFS			122	550
	MX16145HFS			137	620
	MX16175HFS			167	700

* Supplied with 2m cable

Nozzle Heaters

MX 19 Series Nozzle Heaters

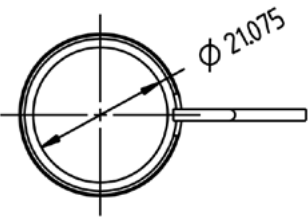
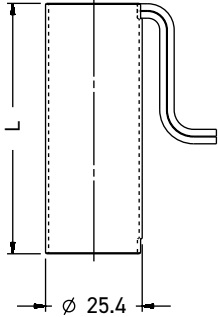
	Mastip Code	Inner Dia (mm)	Outer Dia (mm)	Length (mm)	Watts
	MX19055HFS	21.075	25.4	45.8	400
	MX19065HFS			55.8	470
	MX19075HFS			65.8	470
	MX19095HFS			85.8	550
	MX19115HFS			105.8	620
	MX19130HFS			120.8	620
	MX19145HFS			135.8	700
	MX19175HFS			165.8	850

* Supplied with 2m cable

Nozzle Heaters

TX 16 Series Nozzle Heaters Assembly

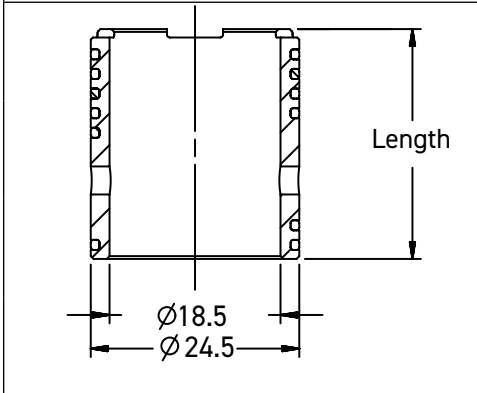
	Mastip Code	Inner Dia (mm)	Outer Dia (mm)	Length (mm)	Watts
		57-016-075	18.5	24.5	51.0
57-016-095		71.0			310
57-016-115		91.0			320
57-016-130		106.0			340
57-016-145		121.0			360
57-016-175		151.0			390

* Supplied with 2m cable

TX 19 Series Nozzle Heaters Assembly

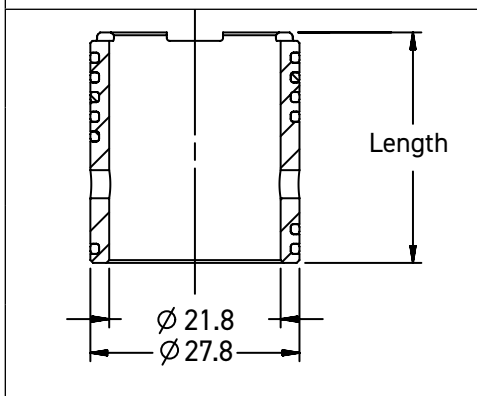
	Mastip Code	Inner Dia (mm)	Outer Dia (mm)	Length (mm)	Watts
		57-019-075	21.8	27.8	48.5
57-019-095		68.5			340
57-019-115		88.5			360
57-019-130		103.5			370
57-019-145		118.5			390
57-019-175		148.5			420

* Supplied with 2m cable

Nozzle Heaters

TX 27 Series Nozzle Heaters Assembly

	Mastip Code	Inner Dia (mm)	Outer Dia (mm)	Length (mm)	Watts
	57-027-075	30.5	37.2	41.0	360
57-027-095	61.0			440	
57-027-115	81.0			450	
57-027-130	96.0			460	
57-027-145	111.0			490	
57-027-175	141.0			530	

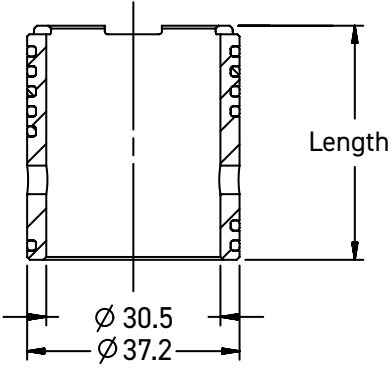
--

* Supplied with 2m cable

Nozzle Heaters

TX Nozzle Coil Heater With Built In TC

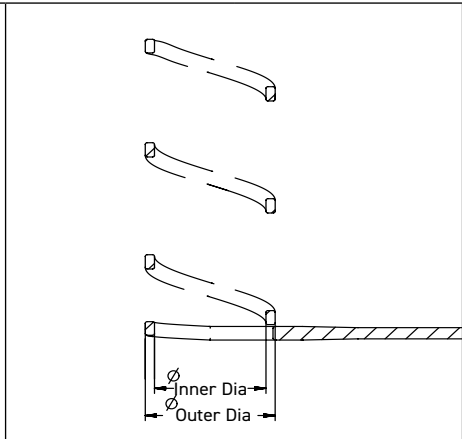
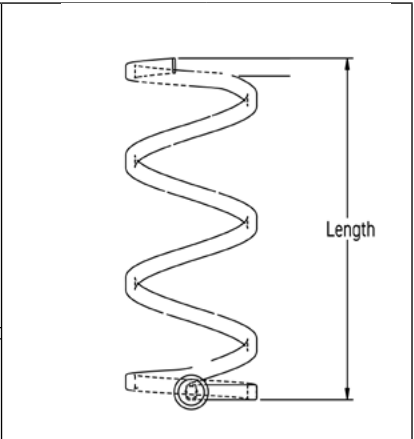
					
Mastip Code	Nozzle Series	Inner Dia (mm)	Outer Dia (mm)	Length (mm)	Watts
57-116-100	16 Series	18.3	23.3	97.0	250
57-116-150				145	330
57-119-100	19 Series	21.6	26.6	97.0	250
57-119-150				145	330
57-127-100	27 Series	30.3	35.3	92.0	330
57-127-150				142.0	400

- * Supplied with 2m cable
- * Inbuilt J type thermocouple

Sprue Bush Heaters

Mastip Code	D(mm)	OD(mm)	Length (mm)	Watts	Cable Length (m)
39-130-020	30	38	20	100	1
39-131-020			20	100	2
39-130-030			30	160	1
39-131-030			30	160	2
39-130-040			40	200	1
39-130-060			60	320	1

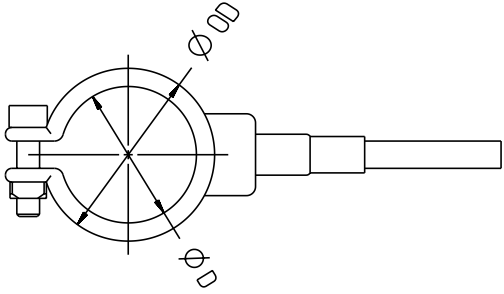
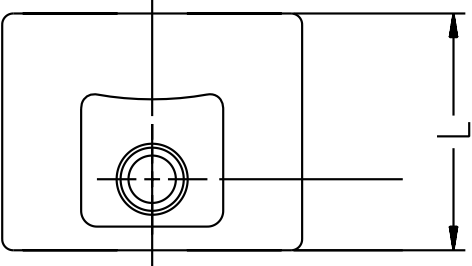
		
---	--	---

*Supplied with J type thermocouple

VeriShot Single Valve Gate Heater

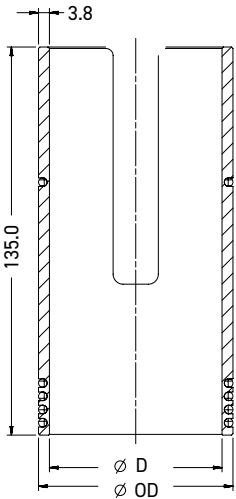
		<table border="1"> <thead> <tr> <th>Mastip Code</th> </tr> </thead> <tbody> <tr> <td>61-001-007</td> </tr> </tbody> </table>	Mastip Code	61-001-007	<table border="1"> <thead> <tr> <th>D(mm)</th> </tr> </thead> <tbody> <tr> <td>60.05</td> </tr> </tbody> </table>	D(mm)	60.05	<table border="1"> <thead> <tr> <th>OD(mm)</th> </tr> </thead> <tbody> <tr> <td>67.65</td> </tr> </tbody> </table>	OD(mm)	67.65	<table border="1"> <thead> <tr> <th>Length (mm)</th> </tr> </thead> <tbody> <tr> <td>135.00</td> </tr> </tbody> </table>	Length (mm)	135.00	<table border="1"> <thead> <tr> <th>Watts</th> </tr> </thead> <tbody> <tr> <td>900</td> </tr> </tbody> </table>	Watts	900
Mastip Code																
61-001-007																
D(mm)																
60.05																
OD(mm)																
67.65																
Length (mm)																
135.00																
Watts																
900																

*Supplied with 2m cable

Manifold Heaters

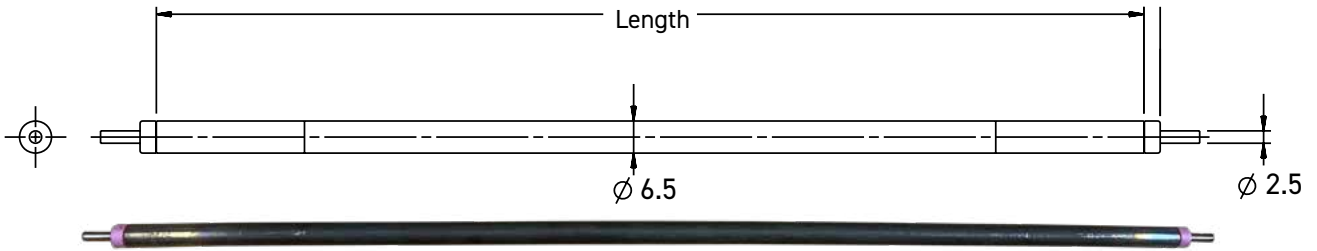



Mastip Code	Length (mm)	Watts
39-650-300	300	450
39-650-325	325	500
39-650-350	350	550
39-650-375	375	600
39-650-400	400	650
39-650-425	425	700
39-650-450	450	750
39-650-475	475	750
39-650-500	500	800
39-650-525	525	850
39-650-550	550	900
39-650-575	575	950
39-650-600	600	1000
39-650-625	625	1050
39-650-650	650	1100
39-650-675	675	1150
39-650-700	700	1200
39-650-725	725	1250
39-650-750	750	1300
39-650-775	775	1300
39-650-800	800	1350
39-650-825	825	1400
39-650-850	850	1450
39-650-875	875	1500
39-650-900	900	1550
39-650-925	925	1600

Mastip Code	Length (mm)	Watts
39-650-950	950	1650
39-650-975	975	1700
39-651-000	1000	1750
39-651-025	1025	1800
39-651-050	1050	1850
39-651-075	1075	1900
39-651-100	1100	1950
39-651-125	1125	2000
39-651-150	1150	2050
39-651-175	1175	2050
39-651-200	1200	2100
39-651-225	1225	2150
39-651-250	1250	2200
39-651-275	1275	2250
39-651-300	1300	2300
39-651-325	1325	2350
39-651-350	1350	2400
39-651-375	1375	2450
39-651-400	1400	2500
39-651-425	1425	2550
39-651-450	1450	2600
39-651-475	1475	2650
39-651-500	1500	2700
39-651-525	1525	2750
39-651-550	1550	2800

*Spare heater sets can be ordered and bending charge will apply.

Heater Spare Parts

Heater Spares Parts

Pictures	Mastip Product Code	Description
	TUBC1	Ceramic Connector For Tubular Heaters
	TUBCERAMIC	Ceramic Ends For Tubular Heaters
	WIRE1.5SIFGB	Wire Copper 1.5sqmm 30/0.25mm RSG Silicon Fibreglass Insulated High Temp

Nozzle Thermocouple

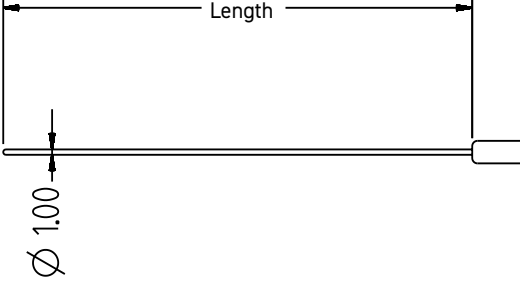



	Mastip Code	Length (mm)
	39-810-060	60
	39-810-090	90
	39-810-120	120
	39-810-150	150
	39-810-180	180
	39-810-200	200
	39-810-225	225
	39-810-250	250
	39-810-275	275
	39-810-300	300
	39-810-325	325
	39-810-350	350
	39-810-375	375
	39-810-400	400
	39-810-450	450
	39-810-500	500
	39-810-550	550
	39-810-600	600
	39-810-650	650
39-810-700	700	

* Thermocouple: J type, grounded

* Cable length: 2m

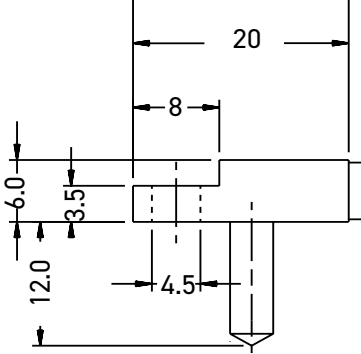
* Measured temperature range: 0°C to 500°C

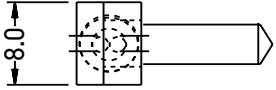
Manifold Thermocouple

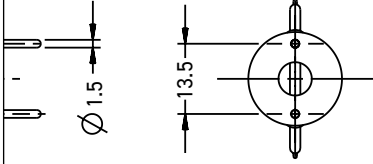
		Mastip Code	Description	Cable Length (m)
		39-800-086	Thermocouple W8x6 4.0x12mm 2m Lead	2
		39-800-286	Thermocouple W8x6 4.0x12mm 4m Lead	4
		39-850-000	Thermocouple HH Dual Probe 1.5x150x2	2

- * Thermocouple: J type, grounded
- * Measured temperature range: 0°C to 400°C



Mastip Head Office New Zealand

Physical Address
558 Rosebank Road, Avondale
Auckland 1026, New Zealand

Postal Address
PO Box 90651, Victoria St West
Auckland 1142, New Zealand

Phone: +64 9 970 2100
Email: mastip@mastip.com

Mastip Regional Office Europe
Phone: +33 0 809 400 076
Email: mastip@mastip.eu

Mastip Regional Office North America
Phone: +1 262 644 9400
Email: northamerica@mastip.com

Mastip Regional Office China
Email: china@mastip.com

For a full list of Distributors,
please visit www.mastip.com